

# Assembly Manual

**On-board Chemical Dosing System (7678.45)  
for Scrubmaster B115 R**

## Introduction

### **Preface**

The installation described in this operating and assembly manual may only be carried out at a Hako Service Center or an authorized Hako service center. The technicians required to complete the work are only available in such service centers.

This assembly manual may only be used in conjunction with the machine's operating manual.

### **Safety information**

Please observe the general safety regulations relevant for the machine provided in the corresponding operating manual.

Switch the machine off and disconnect the battery plug before beginning assembly work.

You are expressly advised that you cannot base any legal claims on the information contained in this manual. Ensure only original spare parts are used should any repairs be necessary. Only such original spare parts warrant that the equipment is reliably ready to use at all times. We reserve the right to make technical modifications in the interest of further development.

Valid as of: July 2014

**Hako GmbH**  
**Hamburger Str. 209-239**  
**D-23843 Bad Oldesloe**  
**Tel. +49 4531 806-0**

# 1 On-board Chemical Dosage

## 1.1 Conversion kit

The conversion kit is comprised of the following parts:

- Hose pump
- Canister
- Holder for canister
- Flow meter
- Dosing hose
- Non-return valve
- T-piece
- Fuse
- Relays
- Cable harnesses, standard parts, labels
- Assembly manual
- Hoses

## On-board Chemical Dosage

### 1.2 Assembling the canister holder



Switch the machine off and disconnect the battery plug!

1. Assemble the holder (Fig. 1/1) of the canister (Fig. 1/2) to the electrical box cover (Fig. 1/4) using hexagon bolts, nuts and washers.
2. Mount the cable clip (Fig. 1/3) on the holder (Fig. 1/1).
3. Insert the canister (Fig. 1/2).



To prevent damage to the electronics, the screws must be inserted on the inside!

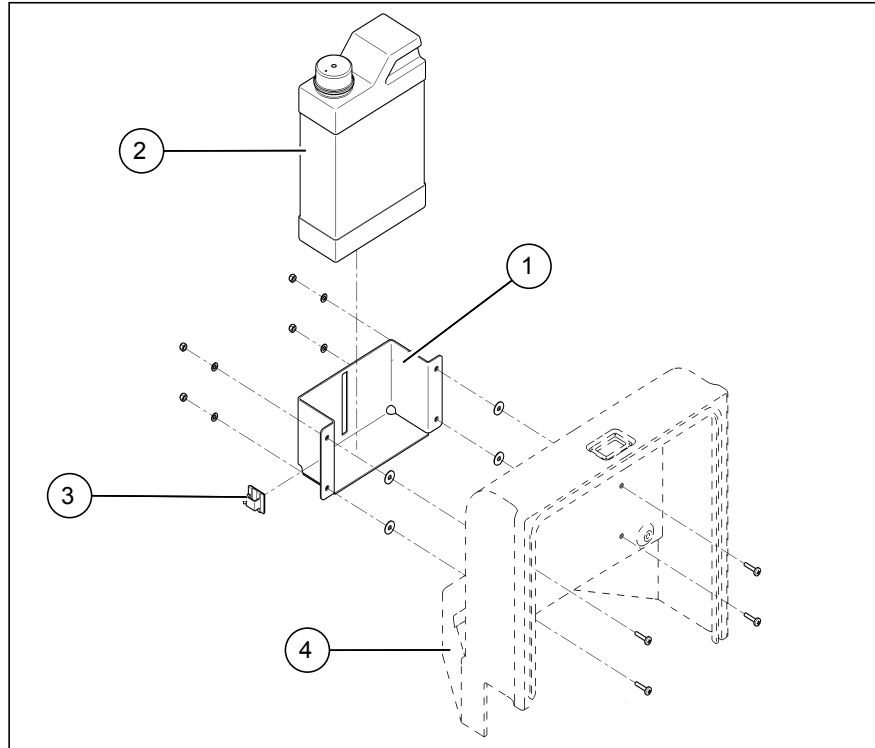

Fig. 1

## On-board Chemical Dosage

### 1.3 Assembling the dosing pump

1. Assemble the dosing pump (Fig. 2/1) on the left-hand holder (Fig. 2/2) of the deflector.
2. Clean the surface and attach the fast emptying label (Fig. 2/3).
3. Fix the cable harness with cable ties. Refer to the circuit diagram for the electrical connection.

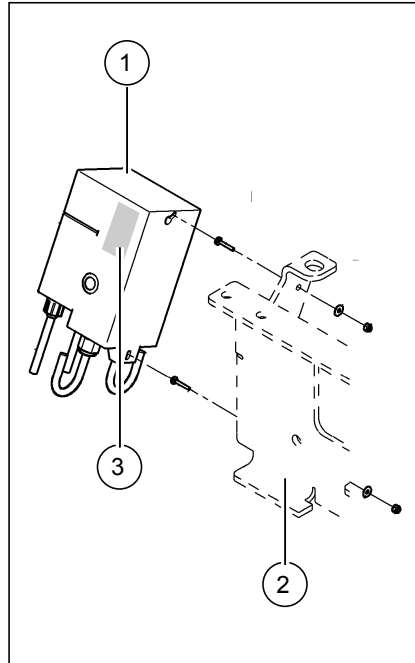

Fig. 2

## On-board Chemical Dosage

### 1.4 Assembling the flow meter

1. Shorten the water hose installed between the relief valve and water pump to 110 mm and the remainder to 70 mm.
2. Install the 110 mm water hose (Fig. 3/1) between the flow meter (Fig. 3/2) and relief valve (Fig. 3/4) using hose clamps.
3. Install the 70 mm water hose (Fig. 3/3) between the flow meter (Fig. 3/2) and water pump using hose clamps.



Observe the flow direction on the flow meter!

4. Fix the protective cap and connector on the flow meter using cable ties.
5. Fix the cable harness with cable ties. Refer to the circuit diagram for the electrical connection.

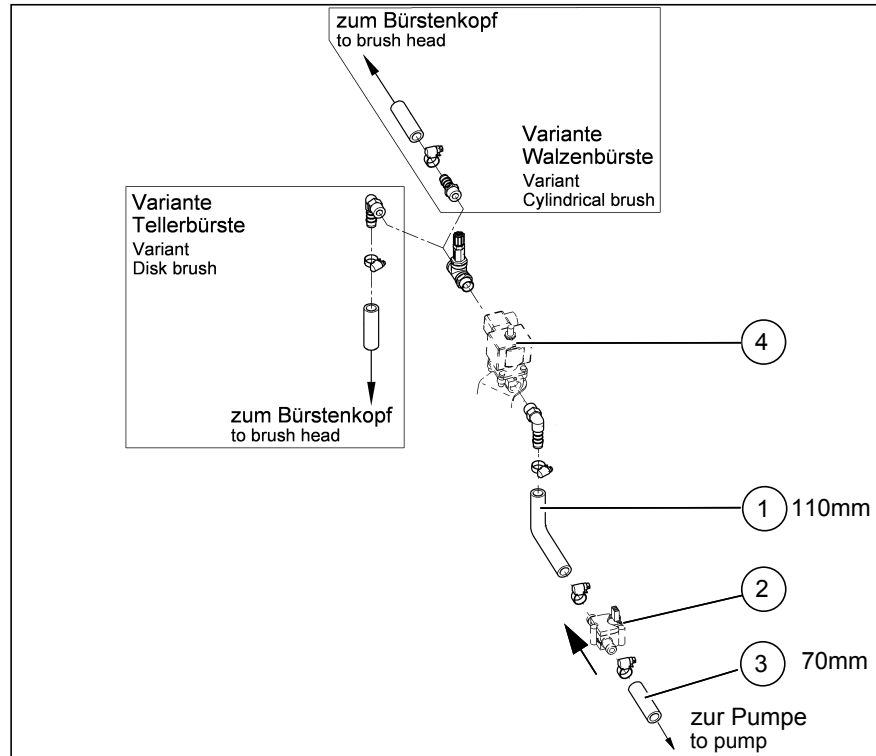

Fig. 3

## On-board Chemical Dosage

### 1.5 Assembling the non-return valve

1. Preassemble the non-return valve (Fig. 4/1) with screw-in sockets (Fig. 4/2) and double nipple.
2. Assemble the non-return valve on the relief valve (Fig. 4/3). Max. tightening torque is 1 Nm!
3. Shorten the water hose (Fig. 4/A) between the brush head and non-return valve according to the length specification in the table and install it using hose clamps.

Brush head	Length
Disk brush head 650	260
Cylindrical brush head 700	140
Disk brush head 750	230
Cylindrical brush head 850	140
Disk brush head 900	220



Seal all the connections with three layers of teflon.

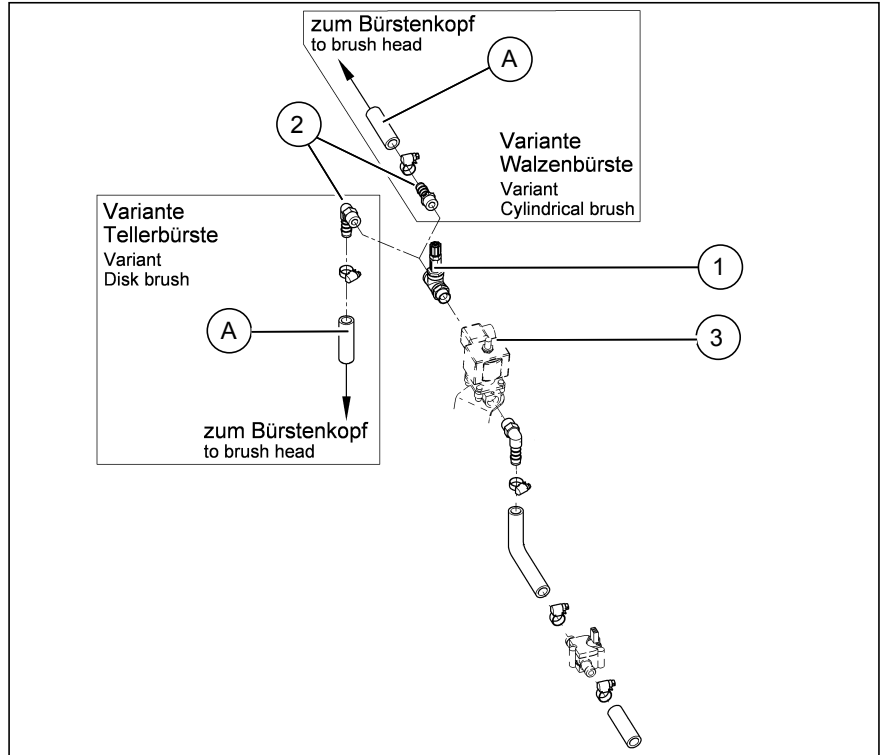

Fig. 4

## On-board Chemical Dosage

### 1.6 Assembling the dosing hose

1. Drill a 6 mm diameter hole in the canister cap (Fig. 5/1) for the dosing hose.
2. Drill a 2 mm diameter hole in the cap for pressure compensation.
3. Fix the dosing hose, 1280 mm long, from the canister (Fig. 5/1) to the dosing pump (Fig. 5/2) (input=A) to the canister holder with cable clips and cable ties.
4. Fix the dosing hose, 1700 mm long, from the dosing pump (Fig. 5/2) (output=B) to the non-return valve (Fig. 5/3) together with the cabling using cable ties.

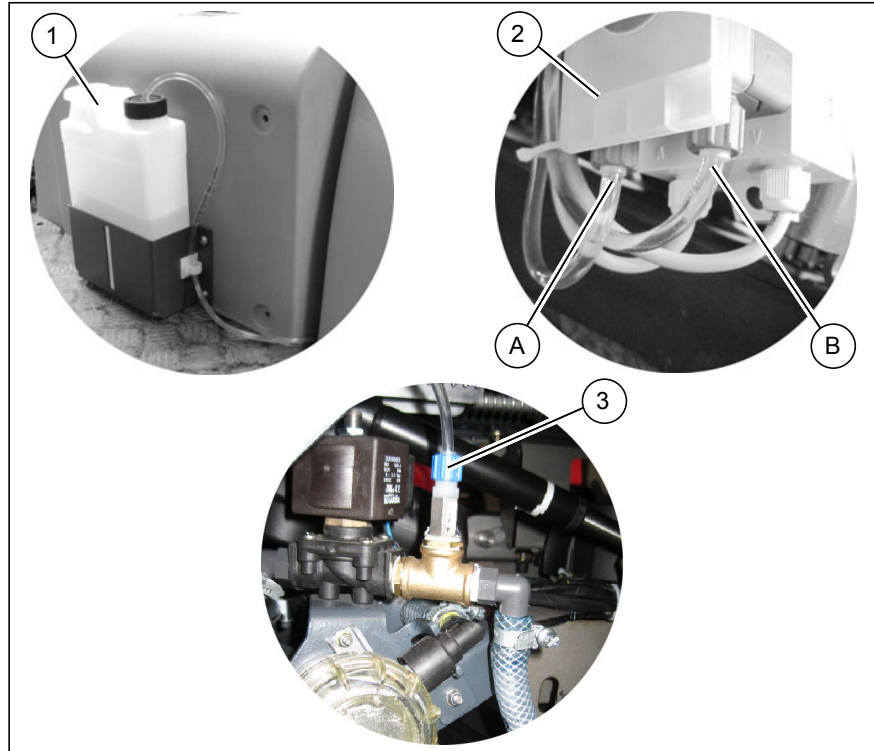

Fig. 5



## On-board Chemical Dosage

### 1.7 Assembling the relay

1. Open the electrical box cover (Fig. 1/4).
2. Assemble the holder (Fig. 6/1) for the relay socket to the plate (Fig. 6/2). Plug the relay (Fig. 6/3) in the relay socket.

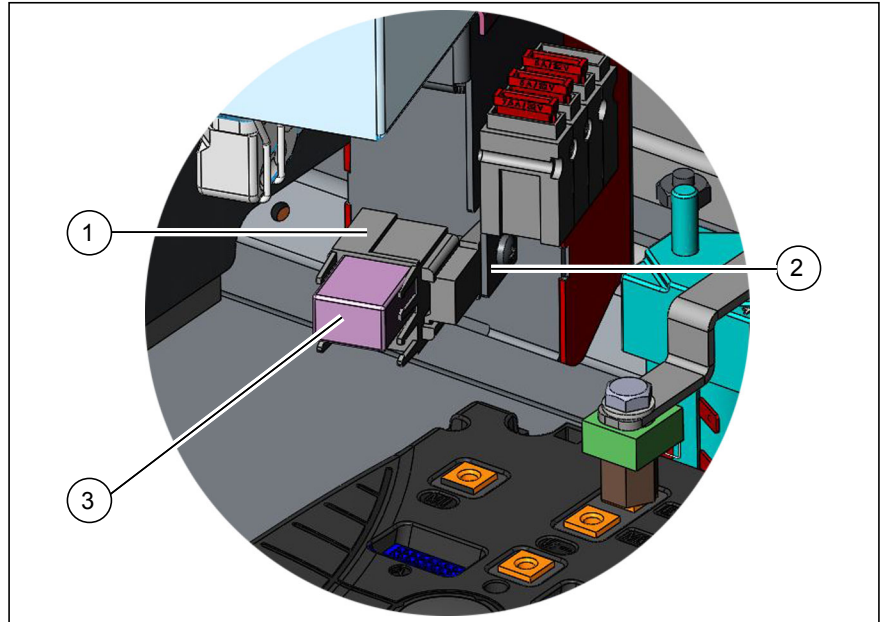

Fig. 6

## On-board Chemical Dosage

### 1.8 Laying the cable harness

1. Plug contact F07 of cable harness W101 in the free slot in the right-hand, pre-assembled fuse holder.
2. Plug fuse link F07 in the free slot.
3. Connect cable harness W101 to relay K101, A04/NBatt (drive control), X37 in the electrical box and fix in place with cable ties. Fix X37 with cable ties.

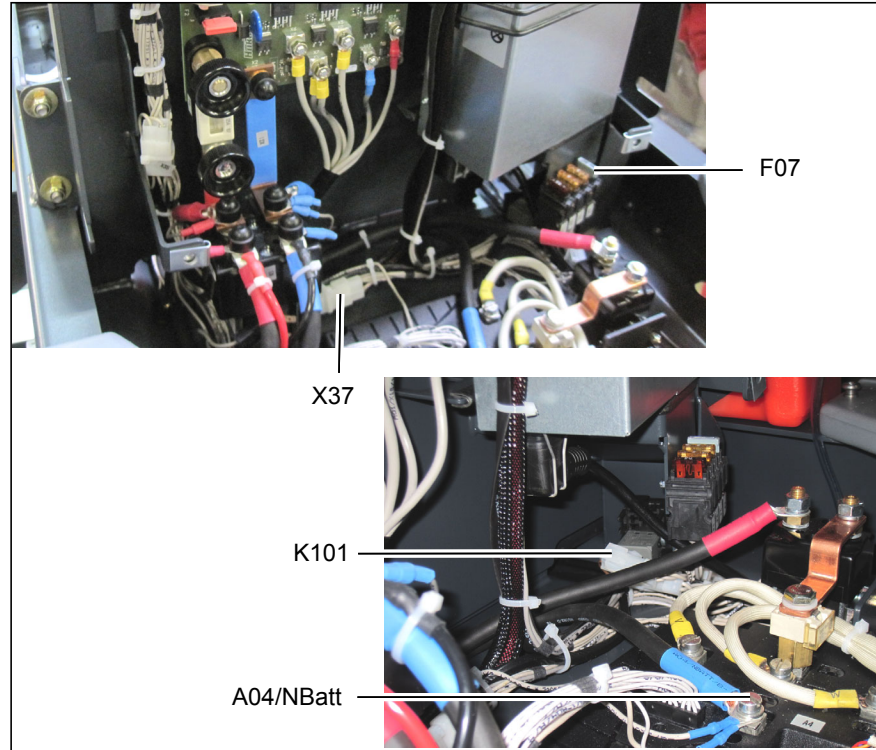
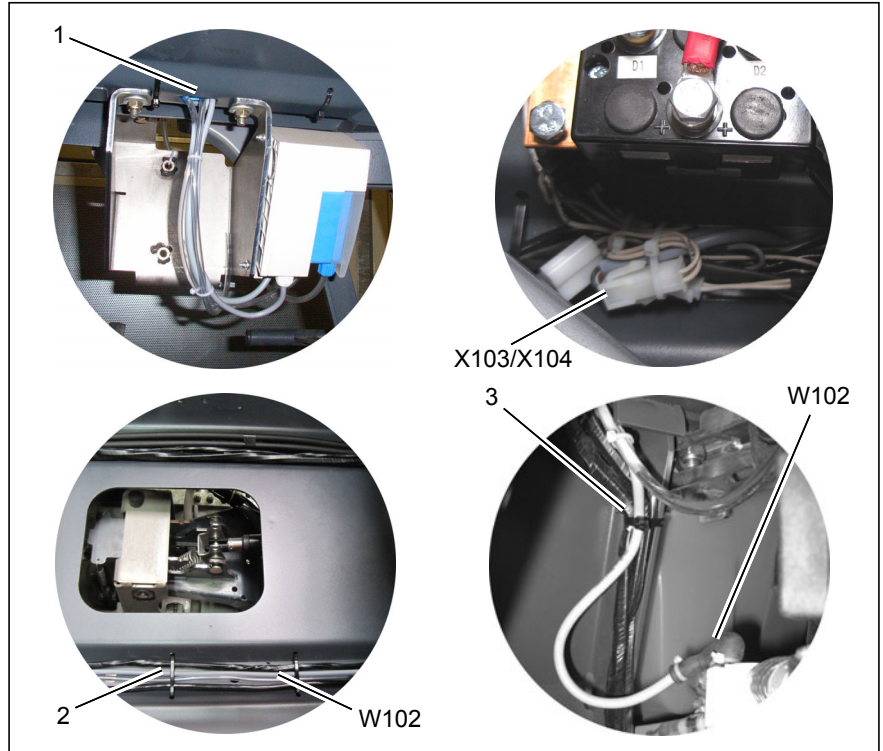

Fig. 7

## On-board Chemical Dosage

4. Feed the dosing pump connection cable and hose through the hole in the chassis (Fig. 8/1) to the electrical box.
5. Connect the dosing pump connection cable with cable harnesses W101 (X103) and W102 (X104) in the electrical box and fix in place with cable ties.
6. Lay cable harness W102 and the silicone hose in the cable duct (Fig. 8/2) illustrated and fix in place with cable ties.  
The cable harnesses and silicone hose must not be jammed when the battery is inserted!
7. Connect cable harness W102 to the flow meter and fix the grommet with cable ties.
8. Fix cable harness W102 to the existing cable harness (Fig. 8/3) using cable ties.



**Fig. 8**

## On-board Chemical Dosage

### 1.9 Activating chemical dosage

The following section describes how the chemical dosage is activated. The following work may only be completed at an authorized Hako service center.

Conditions:

- Batteries have been inserted
- Diagnostics jumper PN 0300 6790 is available

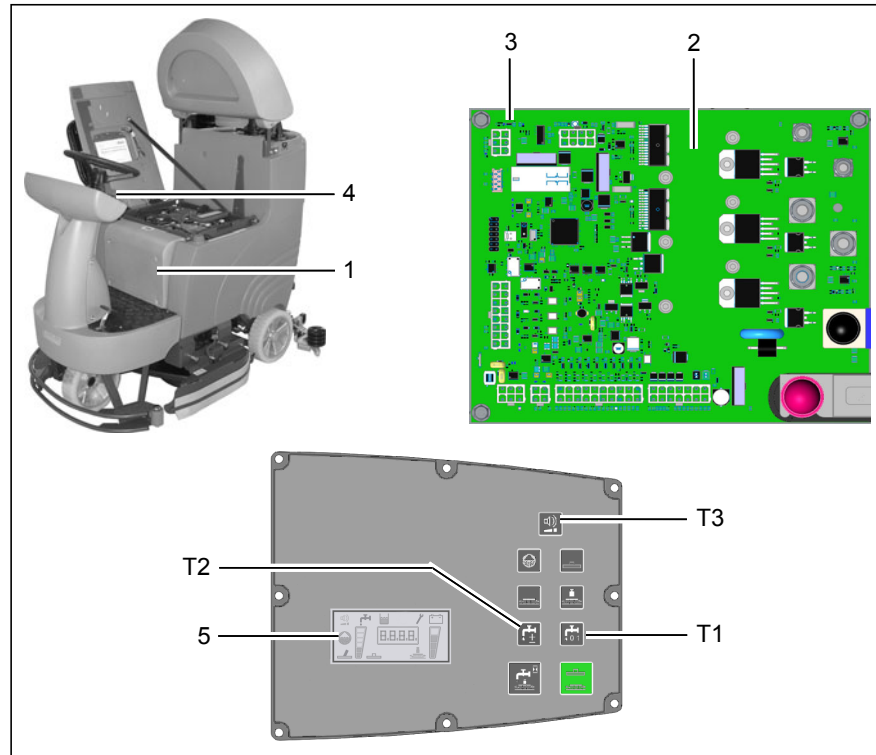

Fig. 9

## On-board Chemical Dosage

1. Open the electronics housing (Fig. 9/1) and plug the diagnostics jumper (Fig. 9/3) on connector - A1.X3 on the control electronics (Fig. 9/2).
2. Open the Configuration menu: Press buttons 1 and 2 simultaneously and then switch on and hold the key switch (Fig. 9/4) for 3 seconds. The right-hand dot flashes in the display (Fig. 9/5):



3. Press button 2 twice. The chapter reference now displays 1. The dot beside the 1 flashes:

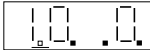

4. Press button 1 once. The dot to the right of the Configuration reference flashes:

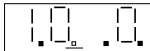

5. Press button 2 twice. The configuration now stands at 2, the content is 0 (chemical dosage is not activated). The dot to the right of Configuration 2 flashes:

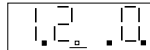

6. Press button 1 once. The dot to the right of the Content reference 0 flashes:

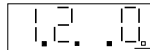

7. Press button 2 once. The content switches to 1 (chemical dosage is activated). The dot to the left of the Content reference 1 disappears:



8. Press and hold button 3 for 3 seconds to save the setting. The dot to the left of the Content reference reappears:

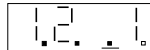

9. This indicates that the value has been saved. Exit from the menu by switching the engine off.
10. Disconnect the diagnostics jumper (Fig. 9/3) from the control electronics and reconnect it to the electronics housing.

# On-board Chemical Dosage

## 1.10 Circuit diagram

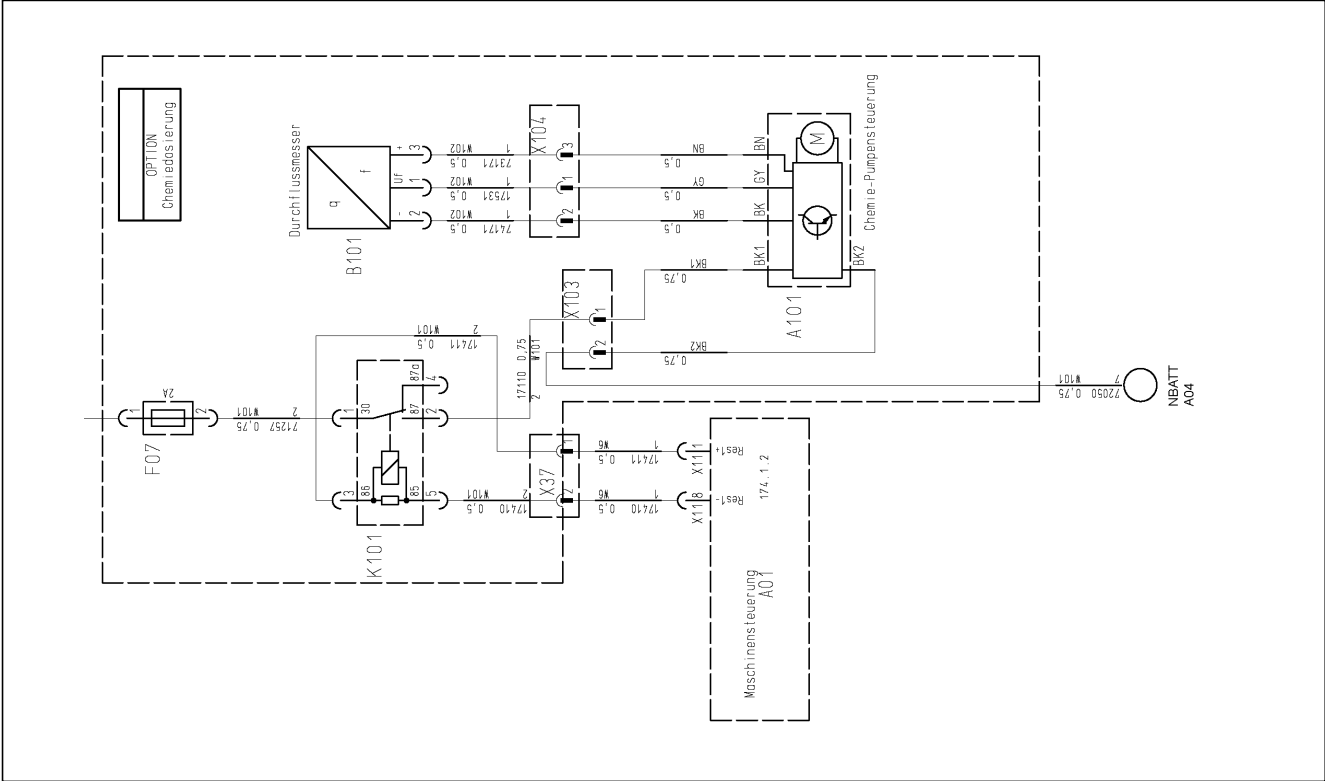

## On-board Chemical Dosage

### 1.11 Operation

#### Starting up

1. Fill the chemical canister with cleaning agent.
2. Switch on the key switch.
3. Switch on the dosing pump switch.
4. Press the quick fill switch (Fig. 10/1) on the dosing pump until the chemical is at the non-return valve.

#### Adjusting the mixture ratio

1. Remove the gray cover (Fig. 10/2) from the dosing pump.
2. Adjust the mixture ratio according to the cleaning agents used.
3. Basic setting = 1:700  
Set rotary knob (Fig. 10/3) between positions 1 and 2, refer to table.

#### Maintenance

Check the hose section (Fig. 10/4) in the hose pump (length approx. 23mm) and replace, if necessary.

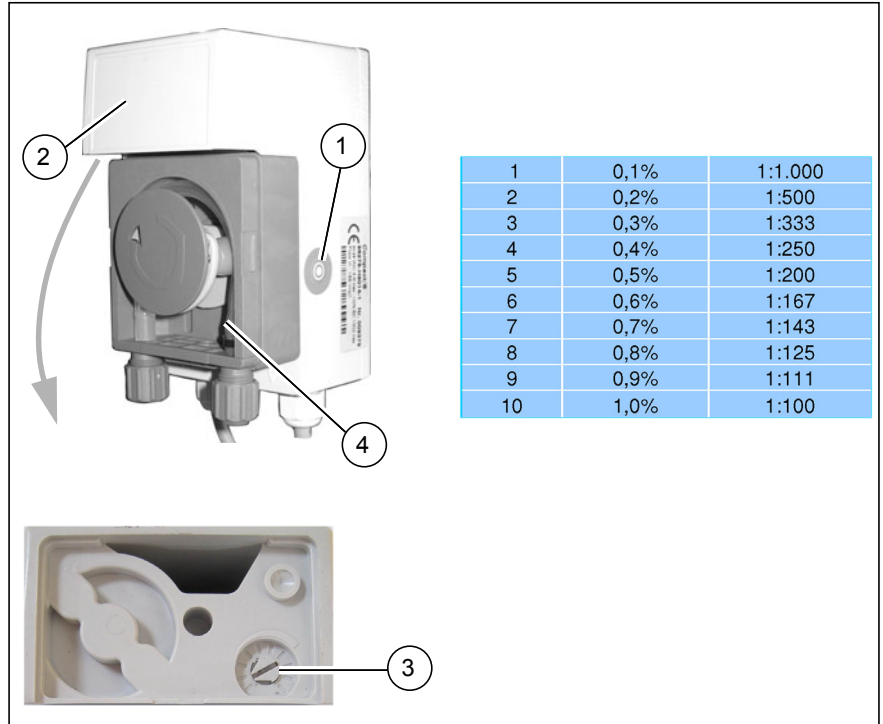

Fig. 10



# Advanced Technology for a Cleaner, Better Environment



Hako GmbH · Hamburger Str. 209-239 · D-23843 Bad Oldesloe  
☎ +49 4531 806-0 · Fax +49 4531 806-338

88-10-2978-2934-00